

U.54A

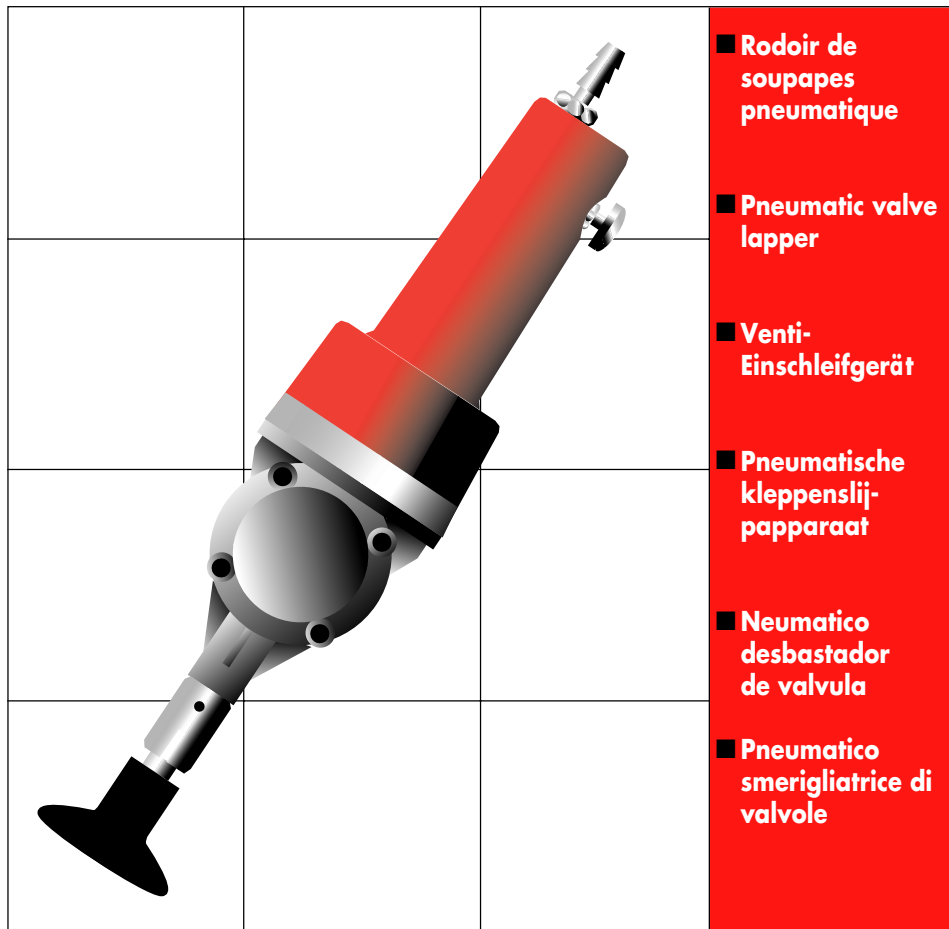

Notice d'instructions
Instruction manual
Bedienungsanleitung
Gebruiksaanwijzing
Guia de instrucciones
Istruzioni per l'utilizzo

NU-U.54A/99

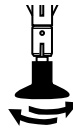
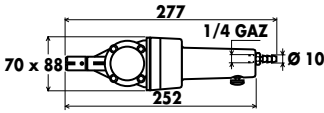

250 c/mn → 3000 c/mn

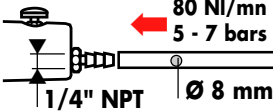

U.54AV1
Ø 22mm



U.54AV2
Ø 33mm

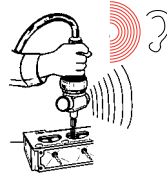

88 db(A)



5,43 m/s²



0,800 kg



U.54AV3
Ø 30mm



U.54AV4
Ø 45mm

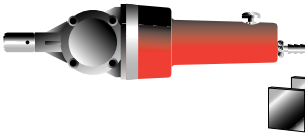

10 bars maxi / 60°C
15 bars maxi / 20°C
600 l/mn maxi

NS.557

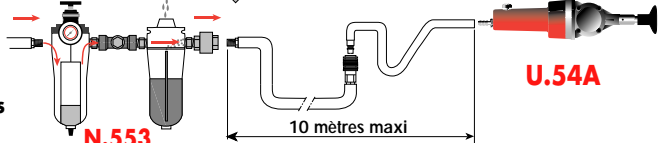

U.54A

5 bars mini
250 c/m

7 bars maxi
3000 c/mn

N.553

250 c/mn → 3000 c/mn

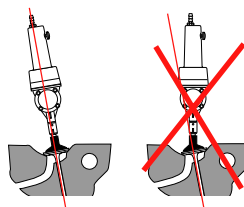
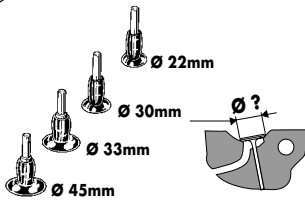

Porter des lunettes de sécurité
Wear eye protectors
Schutzbrille tragen
Een veiligheidsbril dragen
Utilizar gafas de seguridad
Portare gli occhiali di sicurezza

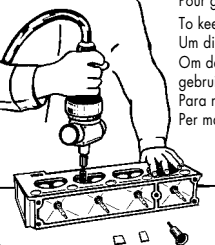

Pour garder la machine en bon état, remplacer les pièces d'usure toutes les 200 heures d'utilisation.
To keep the machine in proper working order, change wear parts after 200 hours to use.
Um die Maschine in gutem Zustand zu erhalten, Gebrauchsteile alle 200 Betriebsstunden austauschen.
Om deze machine in goede staat te houden, dienen de aan slijtage onderhevige onderdelen na 200 uren gebruik te worden verwisseld.
Para mantener la maquina en buen estado, cambiar las piezas de desgaste despues de 200 horas de utilización.
Per mantenere la macchina in buono stato, cambiare le parti d'usura dopo 200 ore di funzionamento.

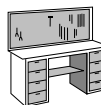

U.54ASE

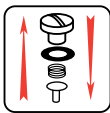

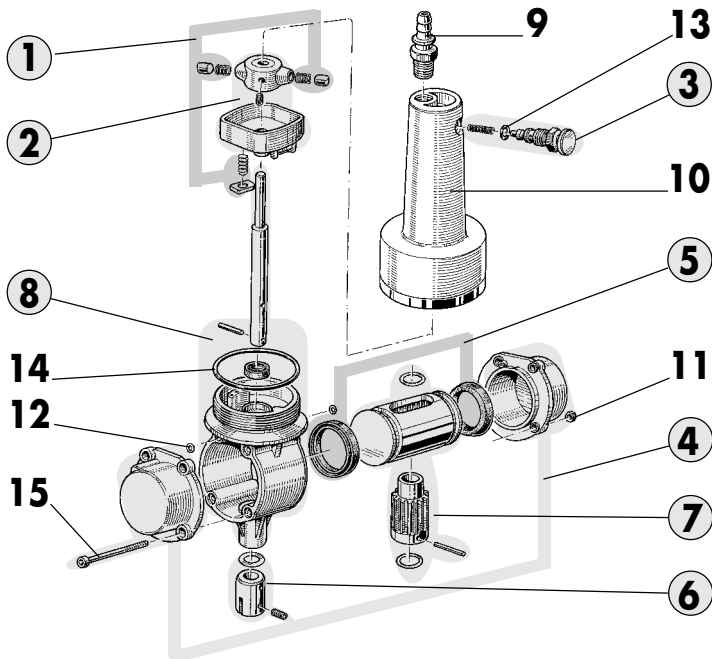
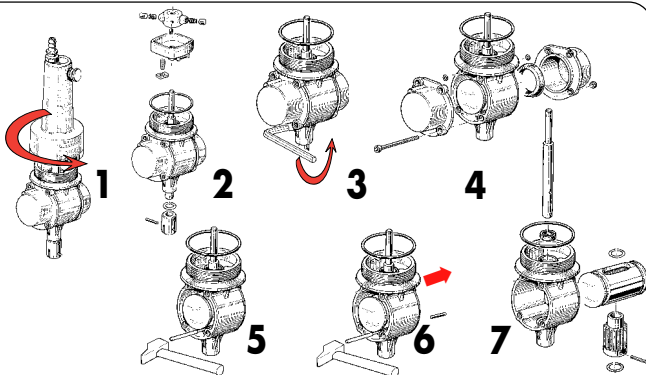
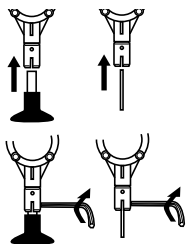
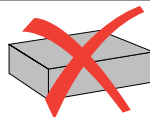

U.54ASE



○		○		○	
①	U.54ASE1	⑥	U.54ASE6	11	<i>ECROU.H,M4</i>
②	U.54ASE2	⑦	U.54ASE7	12	<i>BAGUE.RO0290-178</i>
③	U.54ASE3	⑧	U.54ASE8	13	<i>BAGUE.RO0570-190</i>
④	U.54ASE4	9	NBD.103	14	<i>BAGUE.RO 5500-350</i>
⑤	U.54ASE5	10	U.54A01-30	15	<i>VIS.CHC,M4-50</i>

BELGIQUE FACOM Belgique S.A./NV
LUXEMBOURG Weihoek 4
1930 Zaventem
BELGIQUE
☎: (02) 714 09 00
Fax: (02) 721 24 11

DANMARK FACOM NORDEN A/S
FINLAND Navervej 16B
ISLAND 7451 SUNDS
NORGE DANMARK
SVERIGE ☎: (45) 971 444 55
Fax: (45) 972 444 66

DEUTSCHLAND FACOM GmbH
Postfach 13 22 06 
42049 Wuppertal
Otto-Wells-Straße 9 
42111 Wuppertal
DEUTSCHLAND
☎: (0202) 270 63 0
Fax: (0202) 270 63 50

ESPAÑA FACOM Herramientas SRL
PORTUGAL Poligono industrial de Vallecas
C/.Luis 1º, s/n-Nave 95 - 2ºPl.
28031 Madrid
ESPAÑA
☎: 91 778 21 13
Fax: 91 778 27 53

ITALIA USAG Gruppo FACOM
Via Volta 3
21020 Monvalle (VA)
ITALIA
☎: (0332) 790 111
Fax: (0332) 790 602

NEDERLAND FACOM Gereedschappen BV
Kamerlingh Onnesweg 2
Postbus 134
4130 EC Vianen
NEDERLAND
☎: (0347) 362 362
Fax: (0347) 376 020

SINGAPORE FACOM Tools FAR EAST Pte Ltd
FAR EAST 15 Scotts Road
Thong Teck Building #08.01.02
Singapore 228218
SINGAPORE
☎: (65) 732 0552
Fax: (65) 732 5609

SUISSE FACOM S.A./AG
ÖSTERREICH 12 route Henri-Stéphan
MAGYAROSZAG 1762 Givisiez/Fribourg
ČESKA REP. SUISSE
☎: (4126) 466 42 42
Fax: (4126) 466 38 54

UNITED FACOM Tools LTD
KINGDOM Bridge Wharf - Bridge Road
EIRE CHERTSEY - SURREY KT16-8U
UNITED KINGDOM
☎: (01932) 566 099
Fax: (01932) 562 653

UNITED FACOM TOOLS Inc.
STATES 3535 West 47th Street
Chicago Illinois 60632
U.S.A.
☎: (773) 523 1307
Fax: (773) 523 2103

FRANCE Société FACOM
& 6-8, rue Gustave Eiffel B.P.99
INTERNATIONAL 91423 Morangis cedex
FRANCE
☎: 01 64 54 45 45
Fax: 01 69 09 60 93
http: //www.facom.fr

En France, pour tous renseignements techniques sur l'outillage à main, téléphonez au 01 64 54 45 14

