

BELGIQUE/LUXEMBOURG

FACOM Belgique S.A./NV
 Weihoek 4 1930 Zaventem
 BELGIQUE
 ☎ : (02) 714 09 00
 Fax : (02) 721 24 11

**DANMARK/FINLAND
ISLAND/NORGE
SVERIGE**

FACOM NORDEN A/S
 Navervej 16B
 7451 Sunds
 DANMARK
 ☎ : (45) 971 444 55
 Fax : (45) 971 444 66

DEUTSCHLAND

FACOM GmbH
 Postfach 13 22 06
 42049 Wuppertal
 Otto-Wels-Straße 9
 42111 Wuppertal
 DEUTSCHLAND
 ☎ : (0202) 270 63 0
 Fax : (0202) 270 63 50

ESPAÑA/PORTUGAL

FACOM Herramientas SRL
 Polig. industrial de Vallecas
 C.Luis 1º, s/n-Nave 95 - 2ºPl.
 28031 Madrid
 ESPAÑA
 ☎ : (91) 778 21 13
 Fax : (91) 778 27 53

ITALIA

USAG Gruppo FACOM
 Via Volta 3,
 21020
 Monvalle (VA)
 ITALIA
 ☎ : (0332) 790 111
 Fax : (0331) 790 602

POLSKA

FACOM Oddział w Warszawie
 ul. Marconich 9 m.3
 02-954 Warszawa
 POLSKA
 ☎ : (0048 22) 642 71 14
 Fax : (0048 22) 651 74 69

NEDERLAND

FACOM Gereedschappen BV
 Kamerlingh Onnesweg 2
 Postbus 134
 4130 EC Vianen
 NEDERLAND
 ☎ : (0347) 362362
 Fax : (0347) 376020

SINGAPORE/FAR EAST

FACOM Tools FAR EAST Pte.Ltd
 15 Scotts Road
 Thong Teck Building # 08.01.02
 Singapore 228218
 SINGAPORE
 ☎ : (65) 732 0552
 Fax : (65) 732 5609

**SUISSE/ÖSTERREICH
MAGYARORSZAG
CESKA REP.**

FACOM S.A./AG
 12 route Henri-Stéphane
 1762 Givisiez/Fribourg
 SUISSE
 ☎ : (4126) 466 42 42
 Fax : (4126) 466 38 54

UNITED KINGDOM/EIRE

FACOM -UK
 Churchbridge Works-Walsall Road
 CANNOCK STAFFORDSHIRE WS11 3JR
 UNITED KINGDOM
 ☎ : (01922) 702 150
 Fax : (01922) 702 152

UNITED STATES

FACOM TOOLS Inc.
 3535 West 47th Street
 Chicago Illinois 60632
 U.S.A.
 ☎ : (773) 523 1307
 Fax : (773) 523 2103

**FRANCE ET
INTERNATIONAL**

Société FACOM
 6-8, rue Gustave Eiffel B.P.99
 91423 Morangis cedex
 FRANCE
 ☎ : 01 64 54 45 45
 Fax : 01 69 09 60 93
<http://www.facom.fr>

**U.306A140 - U.306-180
 U.306-260 - U.306A130N
 U.306-170N - U.310-170
 U.310-250 - U.310-250VH
 U.310-230N**

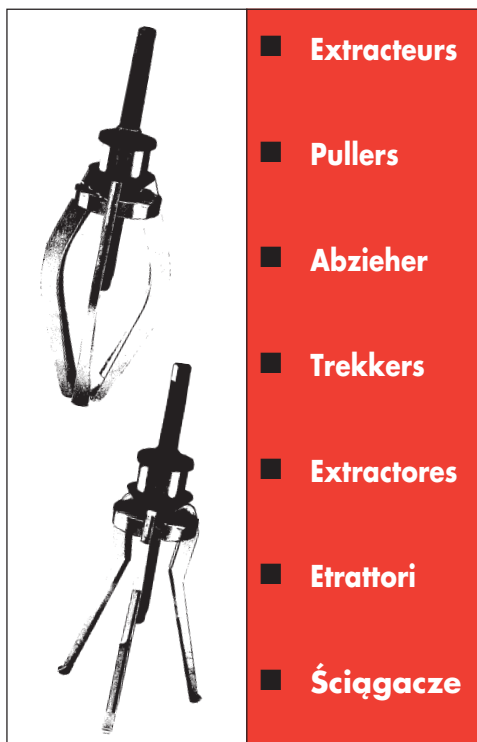
■ **Extracteurs**■ **Pullers**■ **Abzieher**■ **Trekkers**■ **Extractores**■ **Etrattori**■ **Ściągacze**

Notice d'instructions
 Instruction manual
 Bedienungsanleitung
 Gebruiksaanwijzing
 Guia de instrucciones
 Istruzioni per l'utilizzo
 Instrukcja obsługi
NU-U.306A/0901



Utilisation - Use - Gebrauch - Gebruik - Utilizacion - Uso - Użytkowanie

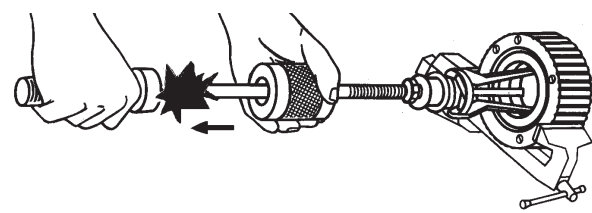
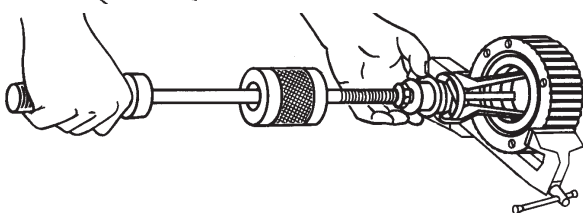
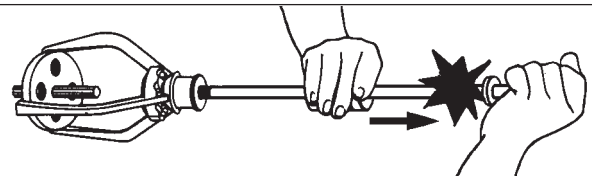
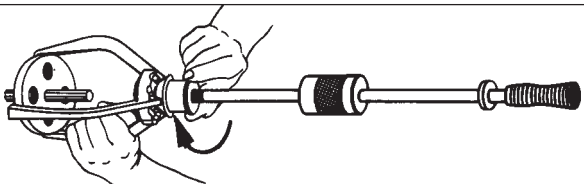
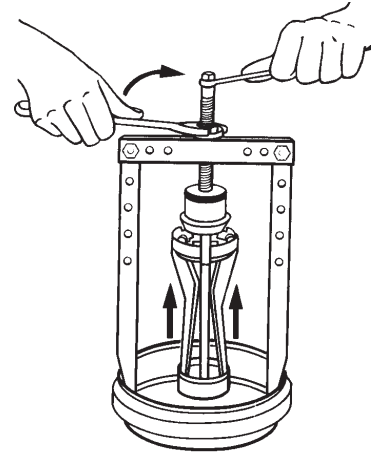
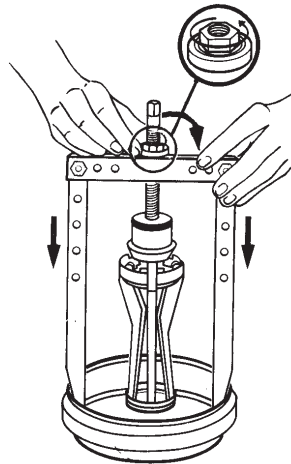
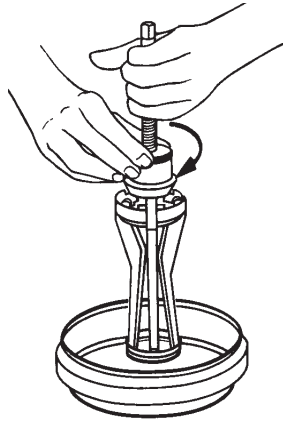
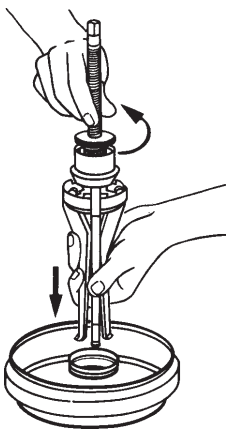
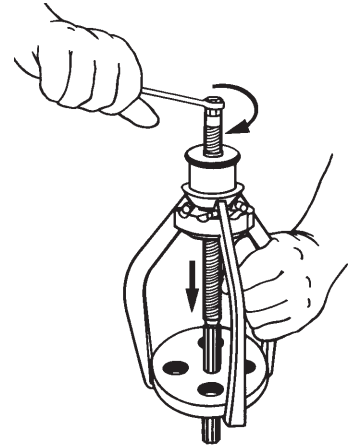
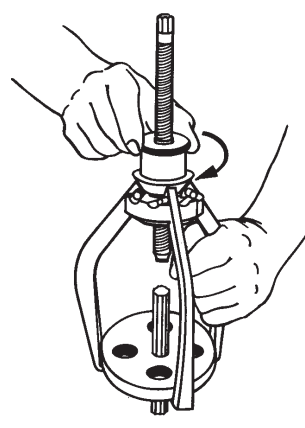
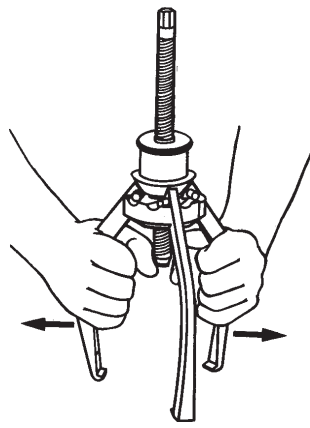
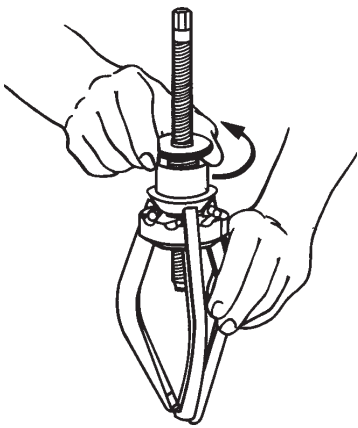
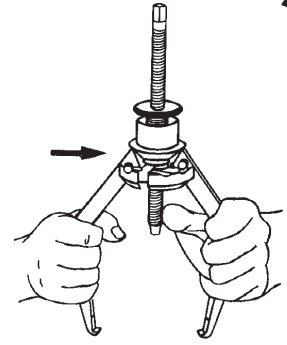
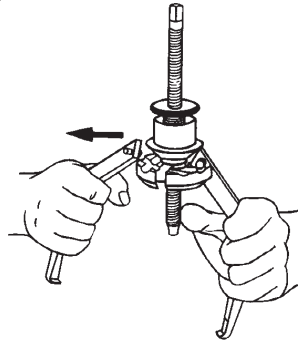
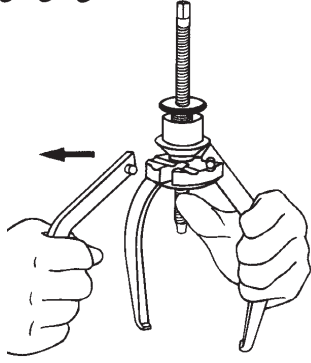
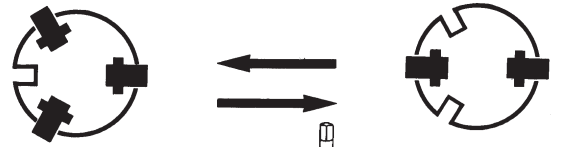

U.306-2 - U.306-4

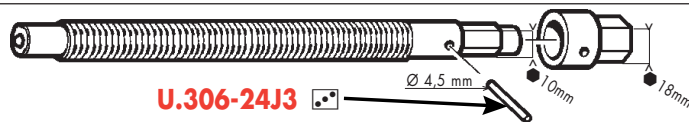



130 Nm maxi

U.306-24J3

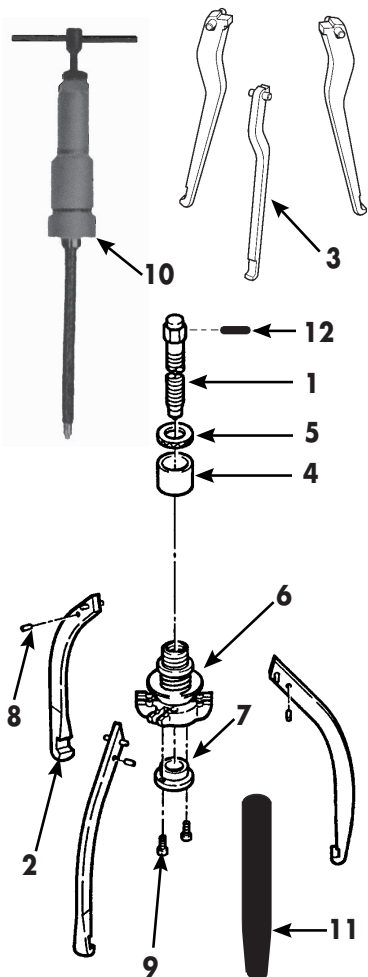
Caractéristiques - Specifications - Kenndaten - Specificaties - Caracteristicas - Caratteristiche - Dane techniczne

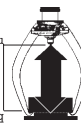

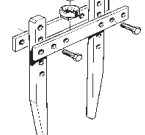
	Ø mini	Ø maxi	Ø mini	Ø maxi				
	mm	mm	mm	mm				
U.306A140	7	140			147	3	U.306M	U.40+U.306A1
U.306-180	10	180			200	4	U.306M	U.40+U.306A1
U.306-260	20	260			250	4	U.306M	U.40+U.306A1
U.306A130N			23	130	140	3	U.306M	U.40+U.306A1
U.306-170N			50	170	190	3	U.306M	U.40+U.306A1
U.310-170	15	170			170	10	U.2	
U.310-250	15	250			250	10	U.2	
U.310-250VH	15	250			250	10	U.2	
U.310-230N			50	230	200	10	U.2	

**Pièces détachées - Spare parts - Ersatzteile - Onderdelen-lijst
Piezas de recambios - Pezzi di ricambio - Części zamienne**

N°	U.306A140	U.306-180	U.306-260	U.306A130N	U.306-170N	U.310-170	U.306-250	U.306-250VH	U.310-230N
1	U.306-4	U.306-2	U.306-2	U.306-4	U.306-2	U.20B1	U.310-250-10		U.20B1
2	U.306G1 (3)	U.306G10 (3)	U.306G15 (3)			U.310G1 (3)	U.310G2 (3)	U.310G2 (3)	
3				U.306G2 (3)	U.306G20 (3)				U.310G3 (3)
4	U.306-06	U.306-06	U.306-06	U.306-06	U.306-06	U.310-250-06	U.310-250-06	U.310-250-06	U.310-250-06
5	U.306-140-07	U.306-140-07	U.306-140-07	U.306-140-07	U.306-140-07	U.310-170-07	U.310-170-07	U.310-170-07	U.310-170-07
6	U.306-19	U.306-19	U.306-19	U.306-19	U.306-19	U.310-19	U.310-19	U.310-19	U.310-19
7						U.310-170-08	U.310-170-08	U.310-170-08	U.310-170-08
8						U.310GP1 (3)	U.310GP1 (3)	U.310GP1 (3)	U.310GP1 (3)
9						VIS.CHC,M6-16(2)	VIS.CHC,M6-16(2)	VIS.CHC,M6-16(2)	VIS.CHC,M6-16(2)
10								U.3	
11			U.306-3-03						
12	U.306-24J3	U.306-24J3	U.306-24J3	U.306-24J3	U.306-24J3				